

DT20 DC Meter

User manual and APP download:

- 1, User manual, PC software installation instruction and PC software and Android APP download link:
<http://en.atorch.cn/upload/20240617105324.rar>
- 2, IOSAPP: search smart life or tuya APP on phone store to download
- 3, Android APP: search smart life or tuya APP at Google play to down load

Built in WiFi module:

Remote Control:Connect the DT20 meter Wi-Fi to 2.4GHz Wi-Fi, then you can monitor or adjust on your phone through the app at any time anywhere.

Product parameters:

- ① Voltage range:DC 0-420V (DC5V independent power supply)
Capacity range: 0-99999AH
Current range: 0~30A/0.1~100A/0.2~200A/0.3~300A/0.4~400A/0.5~500A/0.6~600A(optional)
- ② Support the modification of circuits that require additional relays to be fully charged and fully discharged, which can protect the battery;
- ③ Support low-voltage, over-voltage, over-Power prompt or power outage (when adding 5V relay circuit);
Support bidirectional current testing access,After the line, there is no distinction between the direction of current!
- ④ Support shunt selection: 100A/200A/300A/400A/500A/600A (optional)

Attention:

This product is a bidirectional current test. When discharging, the current displays a "-" symbol. When charging, the current displays a "+" symbol. The capacity test is cumulative, and you need to hold down the "+" and "-" keys to reset zero the capacity. Enter charging or discharging to test the capacity, and the test result is the discharge capacity or charging capacity!

English display interface

Main interface



Alarm interface



Percentage interface



Curve interface



Large font display interface



HID online interface



Bluetooth online interface



WiFi online interface



Language selection interface



Overvoltage alarm interface



Lowvoltage alarm interface



Overpower alarm interface



Scan code to view manual



System Settings 1

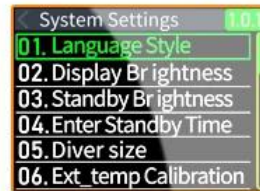

System Settings 2

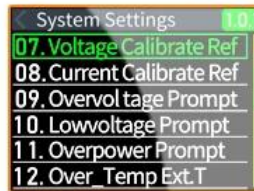

System Settings 3

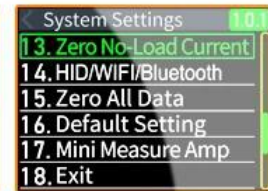

Key operation and introduction

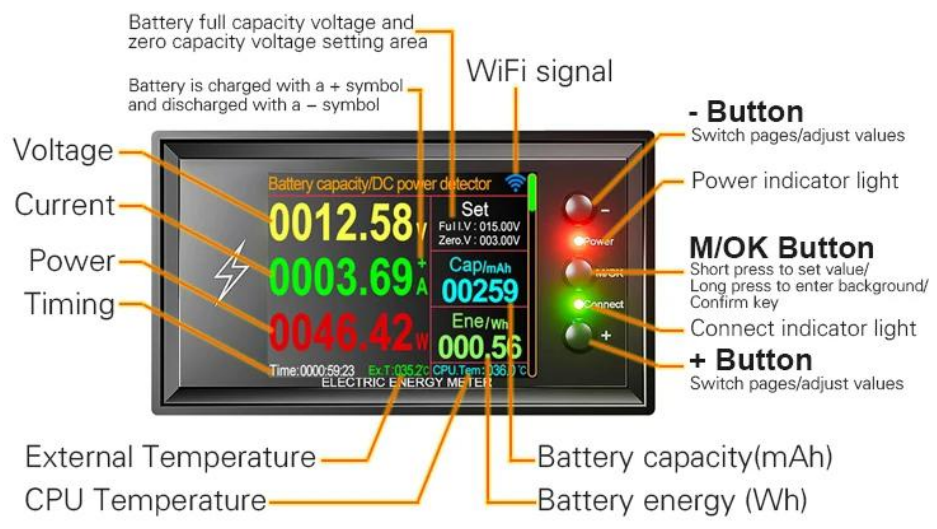

Built-in WIFI module



Alarm buzzer



Temperature probe interface

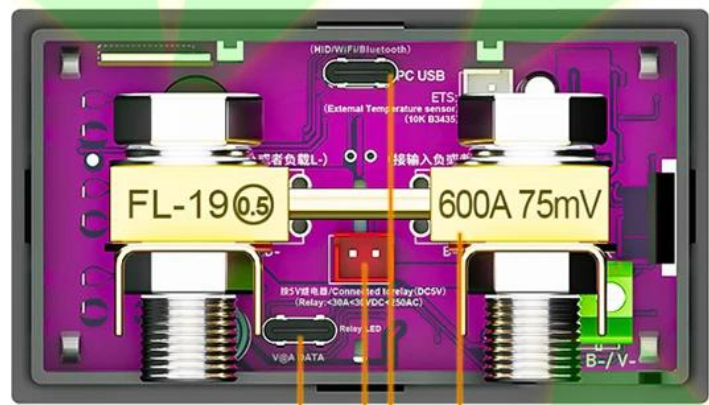

USB independent Power interface

DC5V relay interface

HID data communication interface
(Connected to peripheral devices such as PC/
Bluetooth module/Wi Fi module)

Shunt specifications:
100A/200A/300A/400A/500A/600A (optional)



Battery V+V-

WiFi networking unlimited distance



Voltage current curve & peak recording display interface



Relay needs purchased separately



Pioneering and innovating, serving with dedication
Original and authentic products with quality assurance

Charging and discharging curve and peak recording

Observing the charging and discharging curve and viewing the maximum value

ATORCH has added a curve interface, which makes it easy to query the voltage and current during the discharge process of the battery power supply

The curve, as well as the peak and full range peak recorded values, provides a clearer understanding of the operating state wave amplitude



Voltage Current Curve description

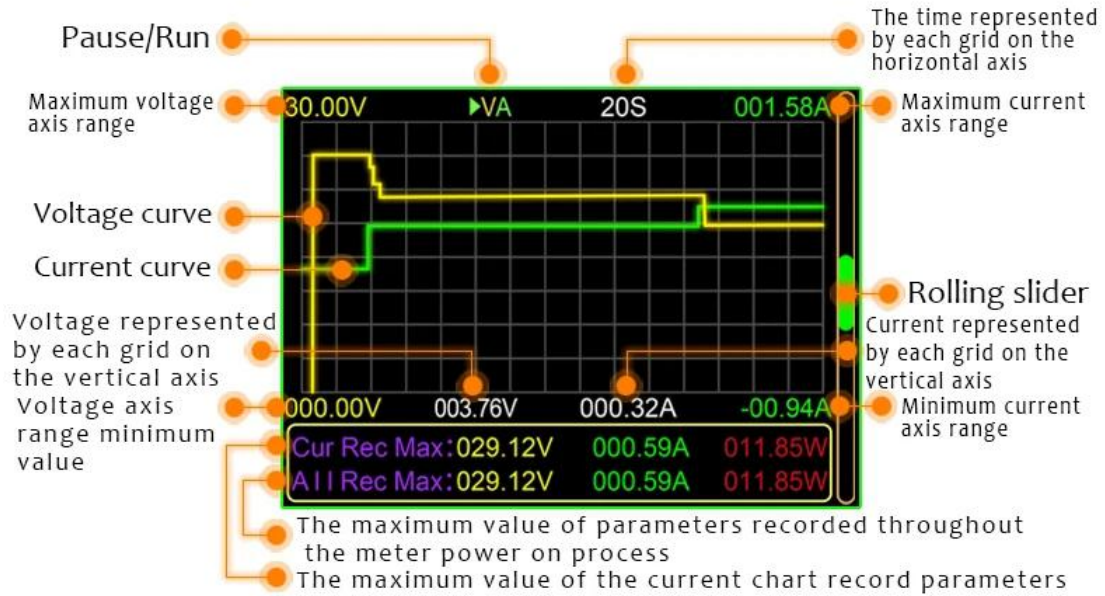

HD Color Screen
Multiple Interfaces

Double alarm of sound and display during Overvoltage, Lowvoltage, Overpower

Long press the M/OK button to enter the backend system and set the overvoltage threshold, lowvoltage threshold, and overvoltage threshold of the tested battery. Afterwards, the device will automatically detect the three parameters of the battery in real time. After reaching the set threshold, the device will simultaneously display alarm content and an internal buzzer will emit a beeping sound as a dual reminder to advise users to use the battery due to low voltage. If the battery capacity is too low, charge it in a timely manner to avoid running out of battery.



Over-voltage alarm interface



Low-voltage alarm interface



Over-power alarm interface



Battery level percentage color change display

High and low threshold free setting for real-time detection of charging and discharging control output

This meter allows users to freely set the corresponding full charge voltage value and minimum discharge voltage value for battery types in the background. After calculating the percentage based on the threshold set by the user, the system displays the percentage color change through the battery symbol (green >30%, yellow < 30%, red < 10%); When the display is within the range of 1% to 100%, the red light on the Power panel lights up, and the relay output interface outputs a high level to control the relay to connect the current path. When it exceeds the range of 1% to 100%, the red light goes out and the relay outputs a low level to disconnect the current path, ensuring safe charging and discharging protection for the battery, avoiding the risk of battery damage due to over-charging and discharging. It can also be used for other purposes of over-voltage and low-voltage disconnection protection.



Connection method

Using 4-wire wiring for more accurate measurements

Whether your battery is lead-acid, ternary lithium battery, lithium iron phosphate, or other types of batteries, as long as it is connected according to the following diagram, all devices within the voltage range of 0~420V can be connected

(Please make sure to supply 5V voltage to the independent power supply interface, so that the instrument can be powered on and the system can run, and the screen will light up.)

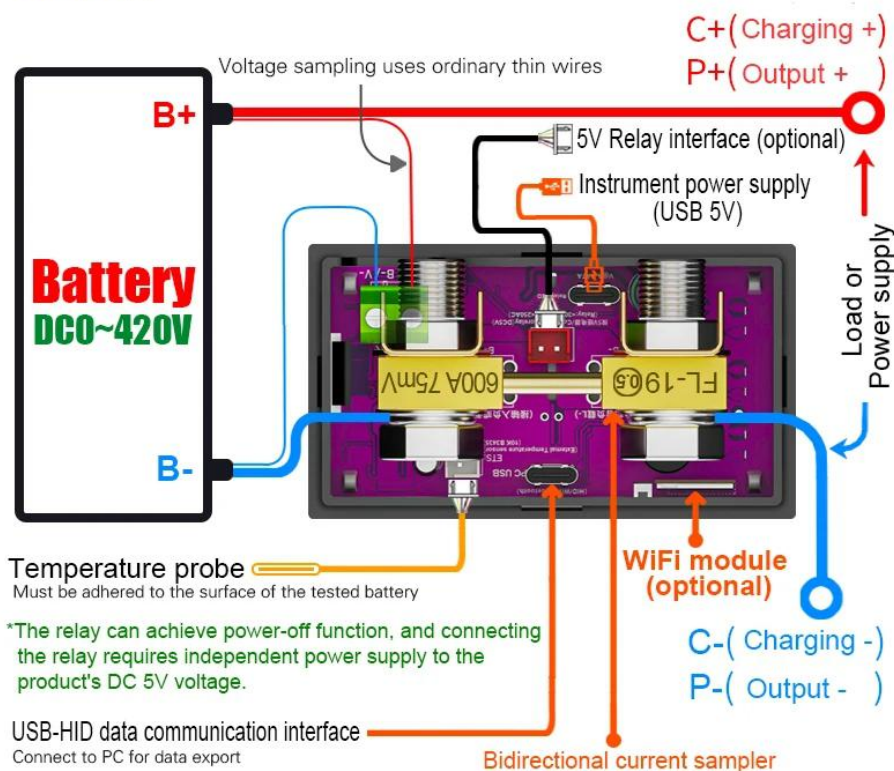

Attention: Please strictly follow the wiring diagram. The sampler must be connected in series to the negative circuit of the battery, and it is strictly prohibited to connect to the positive circuit!

- ① The sampler used in this meter must be connected in series to the negative electrode circuit of the battery pack. The sampler should be connected to the negative electrode B - of the battery, and the P-end should be connected to the negative electrode P -/C - for charging and discharging.
- ② Take one red and one black wire to connect the positive and negative terminals of the battery to the voltage sampling input interface shown in the diagram, for voltage sampling.
- ③ Connect the randomly delivered Type-C data cable to a 5V USB power supply to power the product and it will display normally.
- ④ Wiring principle: Ensure that all current flowing through the battery passes through the bidirectional current sampler shown in the diagram!

Warning: The current line passing through the load should be as thick as possible and meet the required carrying current of the load! The thicker the wire diameter, the better!

Adding Relays to achieve power-off function

Connect according to the diagram below, modify and add additional relay circuits, which can support automatic power-off protection during battery testing when fully charged and fully discharged, as well as automatic power-off protection for overvoltage, overvoltage, and overvoltage during power testing. Test various batteries / power adapters, constant current loads, power banks, etc

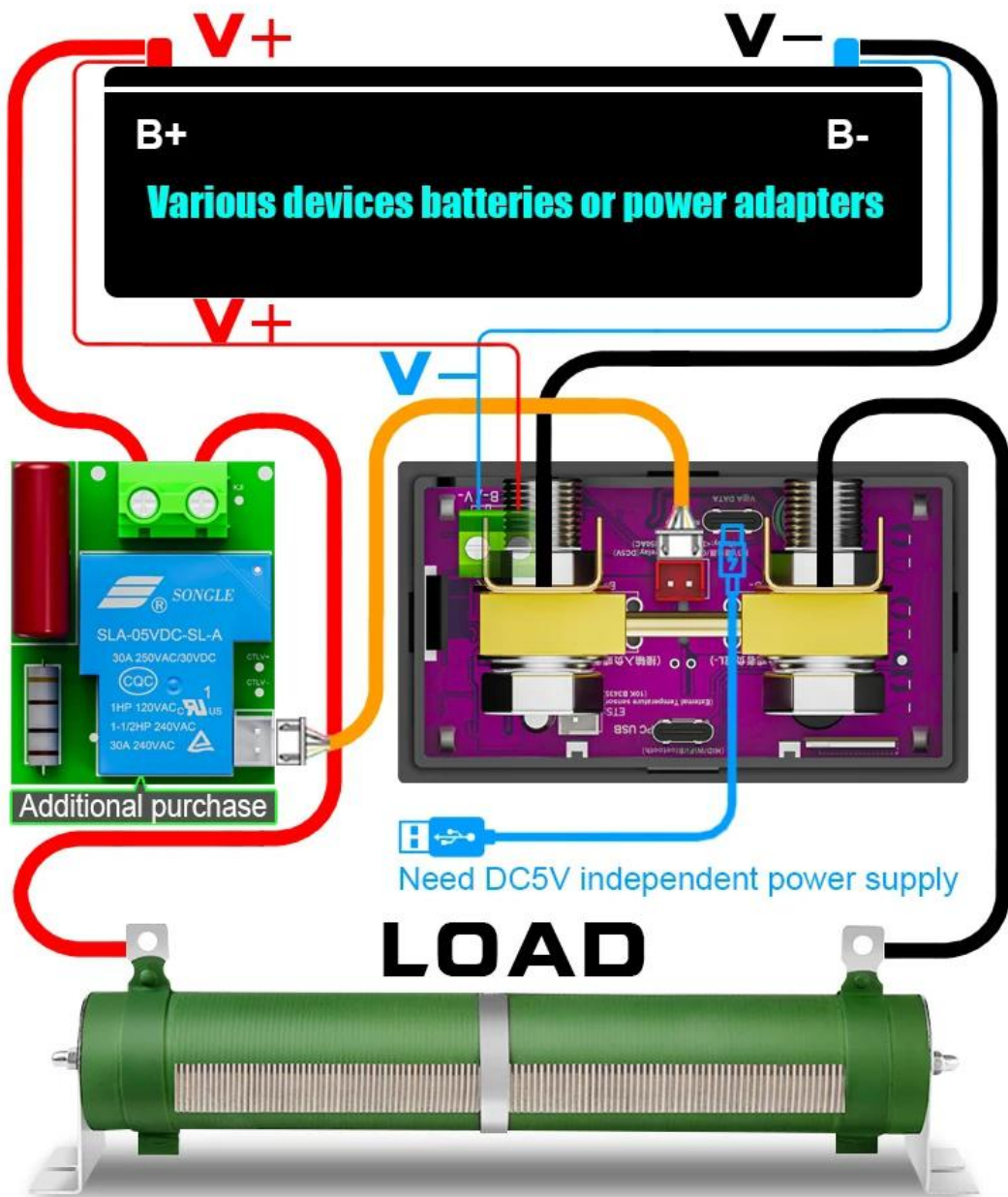

Current voltage accuracy evaluation

Comparison of Precision of Large Professional Instruments

The precision is rigorously calibrated by Torch engineers before leaving the factory. Innovative soft calibration technology is adopted, and software learning precision is achieved through large instruments. Small errors caused by hardware are repaired through software, so that the measurement precision can reach the same precision as large instruments.

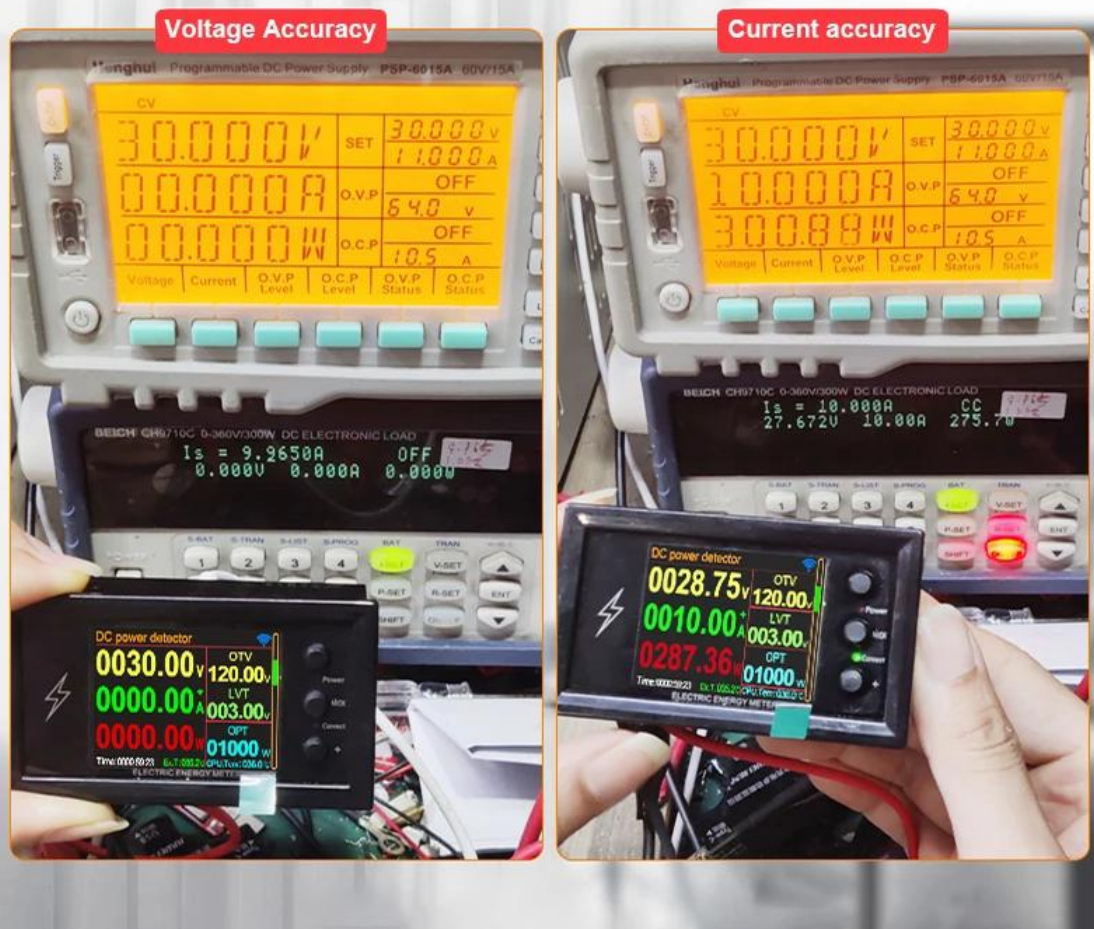

APP WIFI Remote Control

When choosing a style with WiFi connectivity, you can download and install the Smart Life app/Tuya app on your phone to achieve The networked remote control and remote testing functions are rich, almost covering all host functions remotely to mobile apps Manipulation, data monitoring, charging and discharging curve statistics, etc.

APP homepage display



Graphic Display



Display of Internet App Settings Page

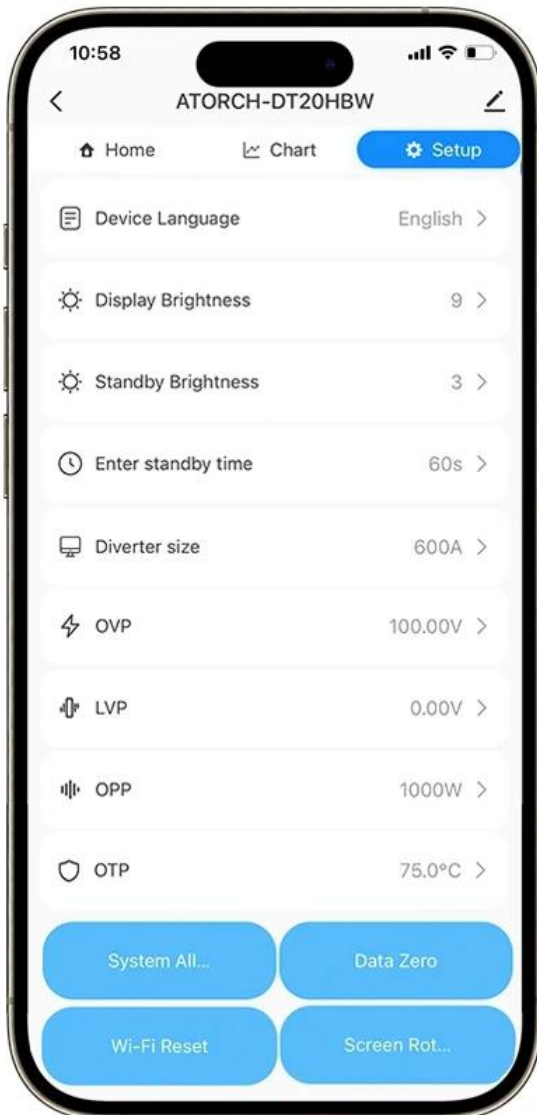

Online computer function

Firstly, install the upper computer software on the computer, and then connect it to the computer through an HID data cable. After automatically recognizing the HID protocol, it realizes rich curve functions, data measurement, and online control of this device. It can also export charging and discharging data documents to other parts and tables, and can also perform firmware updates for lifetime free upgrades through a computer.

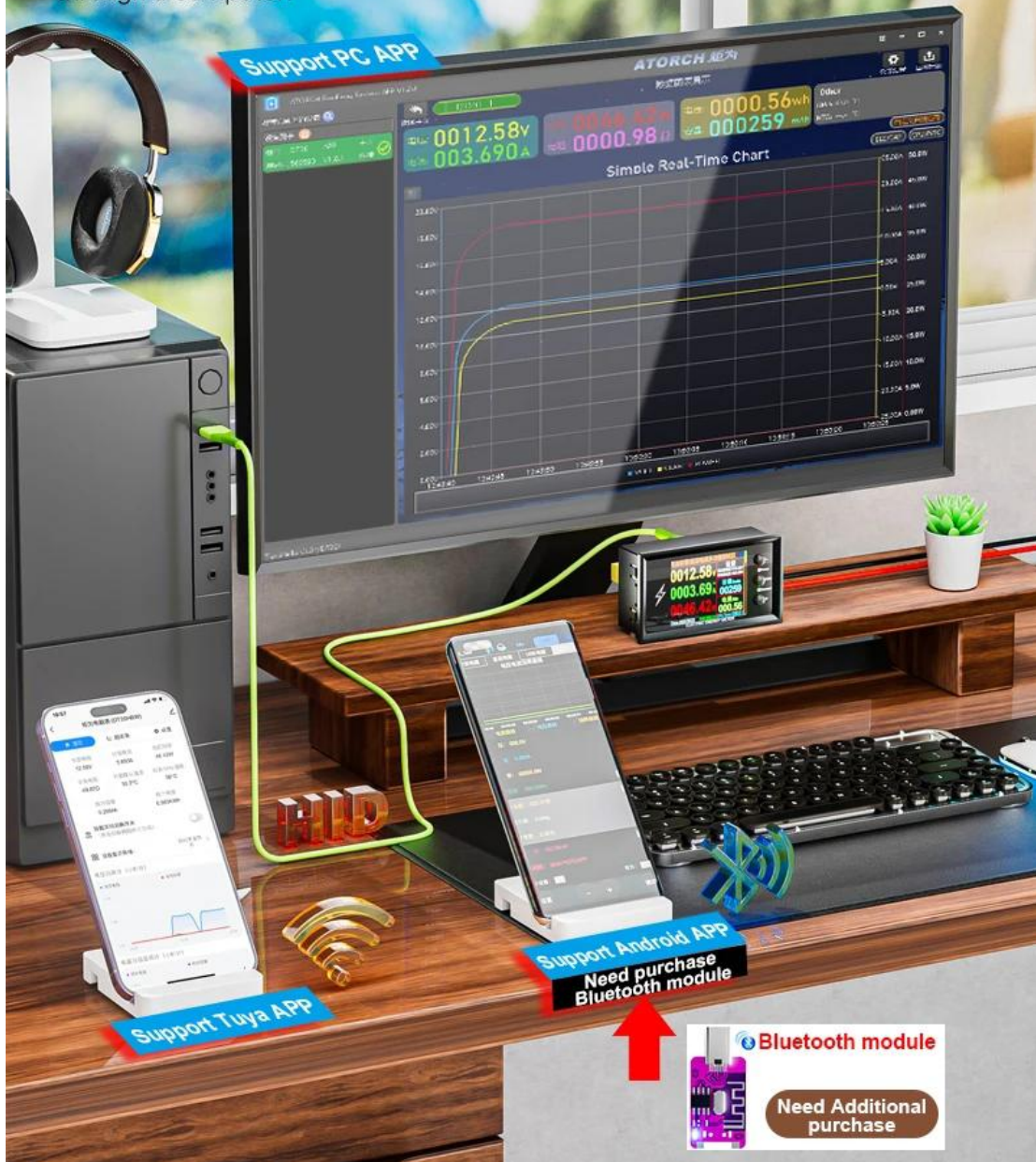

OTA remote firmware upgrade

Firmware update uses an online cable to connect to the computer for upgrade, and ATORCH engineers will update according to the user's needs. After continuously updating the product firmware, new firmware is released to obtain better optimization and more features. Users can purchase it once and upgrade for free for life.



Product parameters

Product
parameters



Product name

Battery capacity/DC power meter

Product model

DT20

Voltage range

0~420V
(Need 5V independent power supply)

Current range

0.1~100A / 0.2~200A
0.3~300A / 0.4~400A
0.5~500A / 0.6~600A

Capacity range

0~99999Ah

Curve function

Current voltage curve,
can pause/run

OPTIONAL ITEMS:

Introduction to relays

1. Need Additional purchase
2. Realize the function of fully charging and power-off the battery, as well as power-off after discharging the battery
3. Implement overvoltage, low-voltage, and power outage functions



5V 30A Relay

Connecting Relay for Attention

- ① When using a relay, it must be powered independently by 5V.
- ② Relay connected to output positive pole
- ③ Independent power supply cannot use the same circuit as the tested power supply
- ④ If the battery is charged, the input is connected to a charger, and the output is connected to a fully charged battery, which will automatically disconnect to protect against the risk of overcharging

****Please do not purchase separately. Please purchase this relay with DT20 series products. If purchased separately, will refuse refund. Thank you!****

Introduction to relays

1. Need Additional purchase
2. Realize the function of fully charging and power-off the battery, as well as power-off after discharging the battery
3. Implement overvoltage, low-voltage, and power outage functions



5V 30A Relay

Connecting Relay for Attention

- ① When using a relay, it must be powered independently by 5V.
- ② Relay connected to output positive pole
- ③ Independent power supply cannot use the same circuit as the tested power supply
- ④ If the battery is charged, the input is connected to a charger, and the output is connected to a fully charged battery, which will automatically disconnect to protect against the risk of overcharging