

TECSUN

FM Stereo/LW/MW/SW SSB PLL Synthesized Receiver

S-8800

OPERATION MANUAL

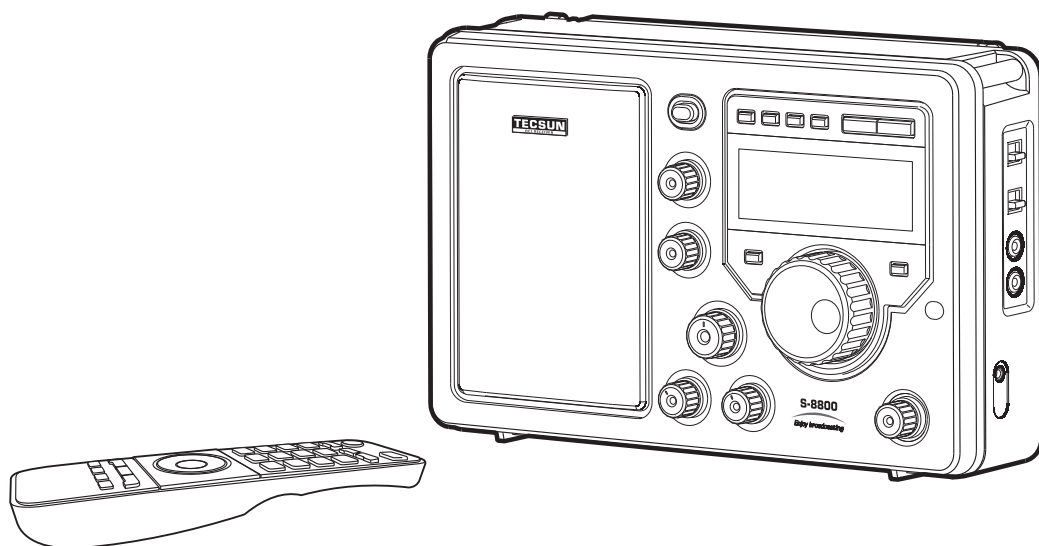

TECSUN ELECTRONIC IND. LTD.

CONTENTS

1. LCD SYMBOL DESCRIPTION	1
2. LOCATION OF CONTROLS (FRONT OF THE RADIO)	2
LOCATION OF CONTROLS (SIDE AND BACK OF THE RADIO)	3
3. REMOTE CONTROL OPERATION	4
4. INSTALLING BATTERIES	5
5. HOW TO TURN ON/OFF THE RADIO	6
6. VOLUME & TONE CONTROL	7
7. MW TUNING STEP & FM FREQUENCY RANGE SETTING	8
8. ANTENNA SELECTION AND CONNECTION	9
Broadcasting knowledge:	
How to achieve long-distance FM radio reception (FM-DX)?	13
9. FREQUENCY BAND SELECTION	13
10. VF (View Frequency) & VM (View Memory) MODE	14
11. TUNING INTO STATIONS	14
12. AM BW (bandwidth) SELECTION	15
13. SSB (Single Side Band) SELECTION	16
Broadcasting knowledge: What is SSB?	16
14. FM STEREO	17
Broadcasting knowledge:	
What kind of signal can interfere with FM broadcasts?	17
How to reduce interference when listening to FM radio?	18
15. STORING STATIONS INTO MEMORY	18
Broadcasting knowledge: Why are more MW stations received at night than during the day?	21
16. LISTENING TO STORED STATIONS	22
17. DELETING STORED STATIONS	23
Broadcasting knowledge: Why is the SW broadcasting sound so unstable, continuously changing between large and small sound? ...	24
18. AUTO SORTING MEMORY	24
19. CLOCK SETTING (24-hour clock)	24
20. ALARM SETTING (by radio only)	25
21. SLEEP TIMER SETTING	26
22. STEREO LISTENING USING EARPHONES	26
23. AUDIO LINE OUT FUNCTION	26
24. DISPLAY & BACKLIGHT FEATURES	27
25. RETURN TO PREVIOUS STATION	27
26. BUILT-IN CHARGING FUNCTION	28
Lithium battery safety information (important!)	28
27. TROUBLE SHOOTING	29
28. FIRMWARE RESET FUNCTION	30
29. SPECIFICATIONS	30
30. RADIO MAINTENANCE	32
Memorandum	33

LCD SYMBOL DESCRIPTION

Clock time, Alarm time (AL), SW meter band (mb),
 Frequency memory storage location (PRESET), Charging time (Charge) indication

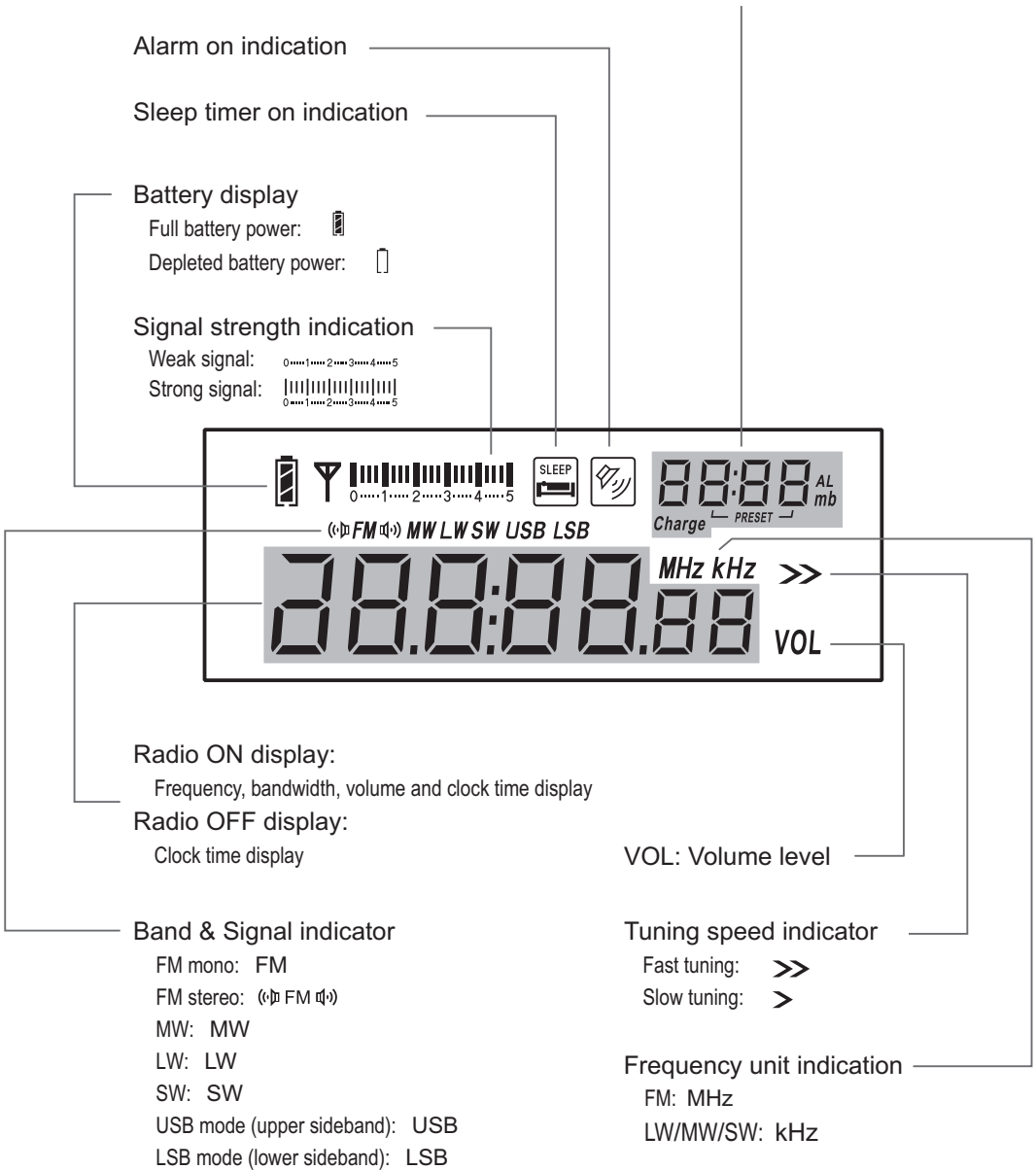

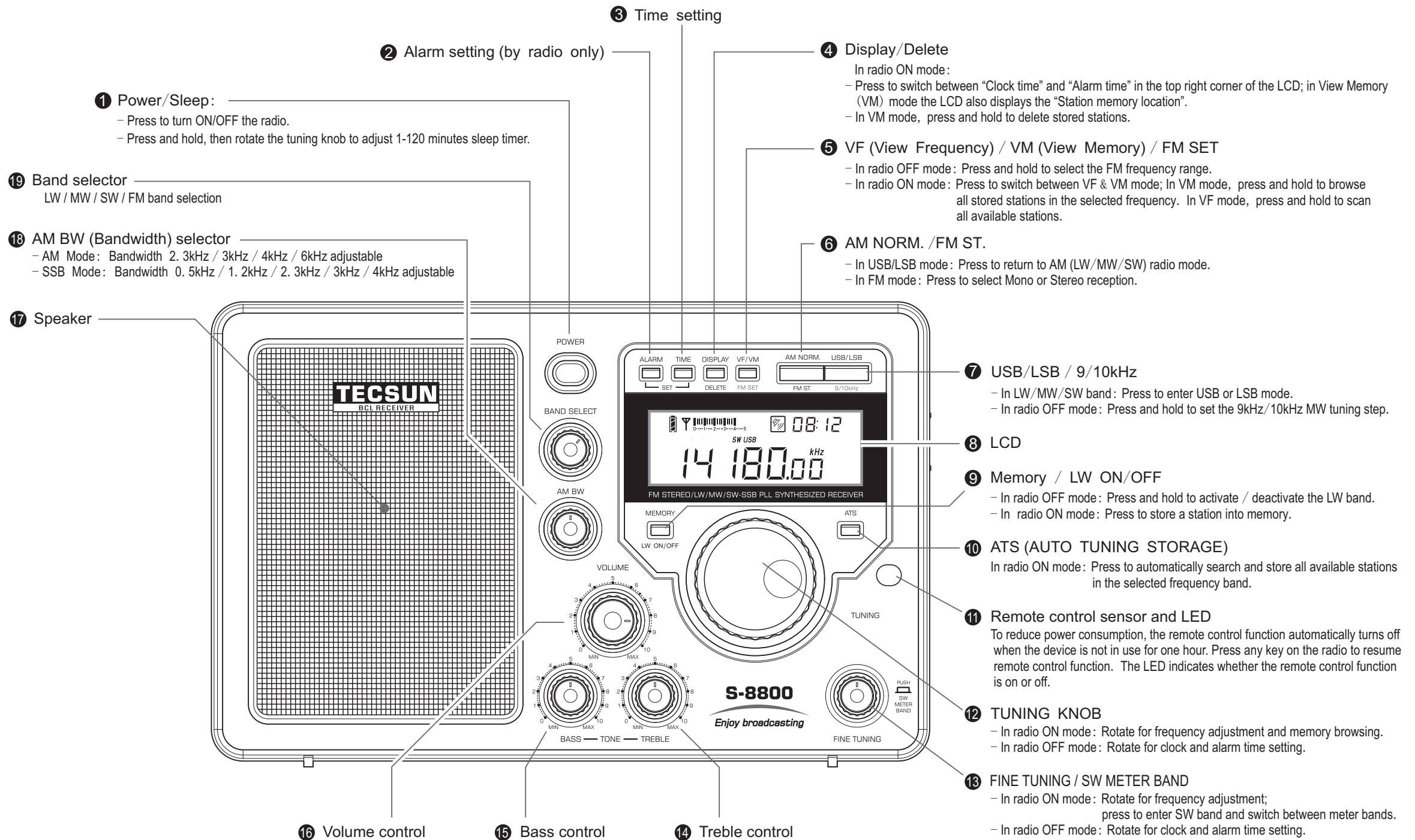

2 LOCATION OF CONTROLS (SIDE AND BACK OF THE RADIO)

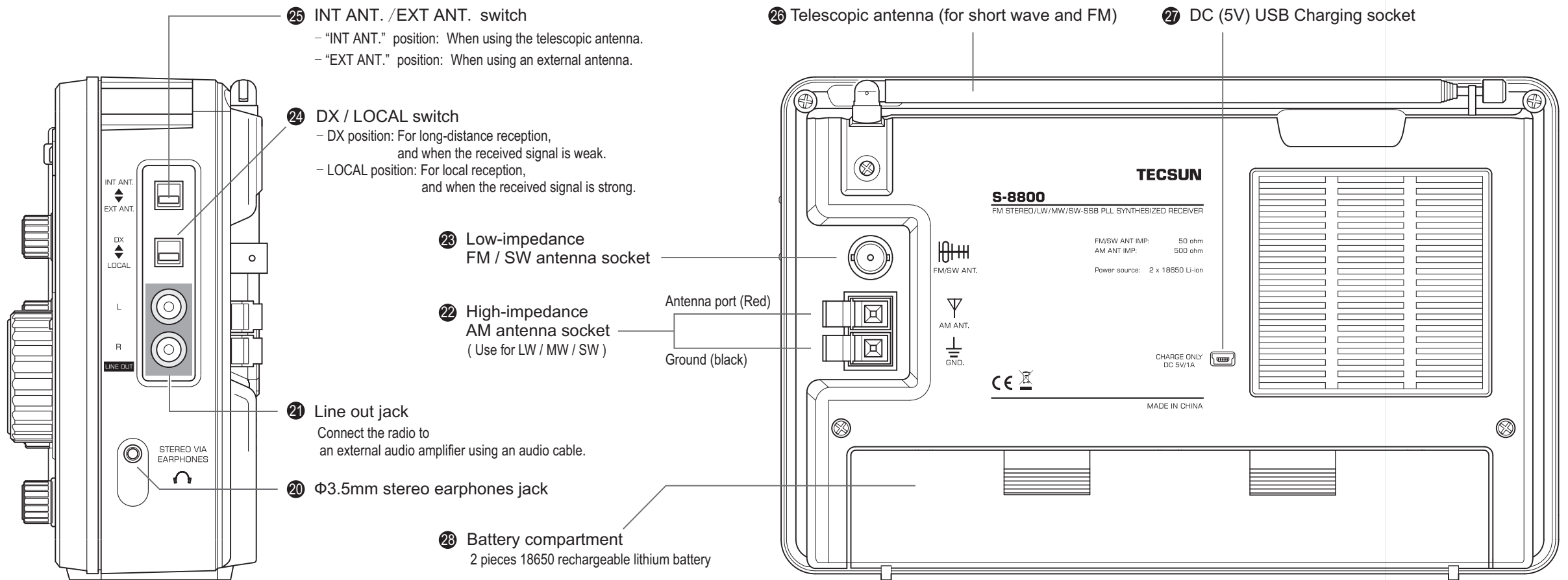

3

REMOTE CONTROL OPERATION

30 Infrared (IR) transmitter (top)

29 Power
Press to turn on/off the device.

49 DISPLAY
Radio ON mode: Press to display either the frequency or clock time on the LCD.

48 M (MEMORY)
Press to display the Station Memory Location, or press to store the station into memory.

47 BACK
Set your desired temporary preset station, then continue tuning into other stations. At any time, press [BACK] to return to the temporary preset station.

46 TUNING
Adjust the frequency or select a stored station memory location (in VM mode only).

45 VF/VM
In radio ON mode, press to switch between the View Frequency (VF) and View Memory (VM) modes.

44 SCAN
In VF mode, press and hold to scan all available stations in the selected frequency band. In VM mode, press and hold to scan all available stored stations in the selected frequency band.

43 AM NORM. / FM ST.
- In SSB mode: Press to return to LW/MW/SW reception.
- In FM mode: Press to select FM mono or stereo.

42 USB/LSB
While receiving LW/MW/SW signals, press to select USB or LSB mode.

41 SW- / SW+
Radio ON mode:
- Press to select the SW band, press again to change SW meter band.
- Press and hold to automatically tune into stations and store them into memory (ATS).

40 Battery compartment (back side)
Requires 2pcs AAA size battery

31 Sleep timer setting
Turn on the radio, press repeatedly to select your desired auto turn off timer (1 to 120 minutes).

32 DELETE
- ALL: In VM mode, select desired frequency band, then press and hold to activate delete function, press again to confirm.
- ONE: In VM mode, select desired frequency band, press and hold to activate delete function, press again to confirm.

33 Multifunctional numeric keys
- Frequency input (VF mode)
- Memory location input for stored stations (VM mode)

34 ENTER
Press to confirm setting.

35 Auto sorting memory ("0" key)

36 Volume
- VOL + : Increase volume level / line out signal level
- VOL - : Decrease volume level / line out signal level

37 AM BW bandwidth filter
Select the frequency band (LW/MW/SW), then press repeatedly to apply the desired bandwidth filter.
- AM mode: 2.3kHz / 3kHz / 4kHz / 6kHz
- SSB mode: 0.5kHz / 1.2kHz / 2.3kHz / 3kHz / 4kHz

38 FM/FM SET
- Radio OFF mode: Press and hold to select your desired FM frequency range.
- Radio ON mode: Press to select FM band, or press and hold to automatically tune into stations and store them into memory (ATS).

39 MW / 9/10kHz
- Radio OFF mode: Press to select 9kHz or 10kHz MW tuning steps.
- Radio ON mode: Press to select MW band, or press and hold to automatically tune into stations and store them into memory (ATS).

Don't press!
Water ingress prevention only.

4

INSTALLING BATTERIES (RADIO)

1. Open the battery compartment located at the back of the unit.

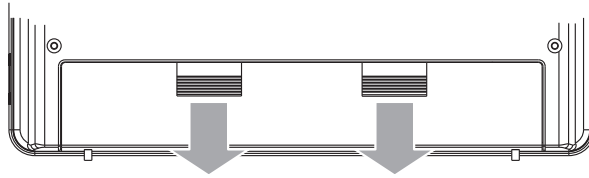

2. Correctly install two 18650 lithium batteries by following the polarity diagram.

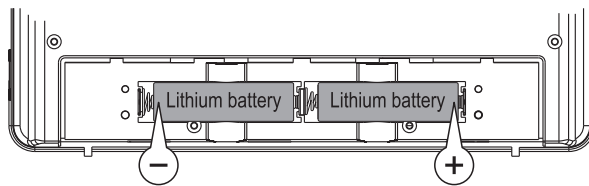

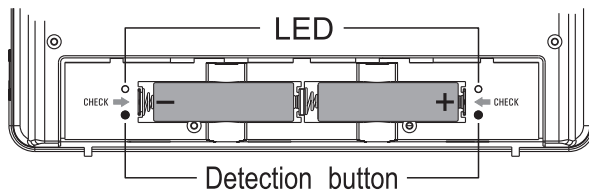

Note:

This device has battery detection circuits, supplied with detection buttons and LEDs located at both ends of the battery compartment. After inserting a lithium battery, press the detection button. When the LED light is on, this indicates that the lithium battery is suitable for use. If the light is off, the battery is damaged and should be promptly replaced.



3. Close the battery door.

Note: When the inserted batteries are fully charged, the battery indicator on the LCD shows full power “”. If the battery indicator shows low power “” and is blinking, the battery is about to run out. “” indicates that the operating voltage is insufficient, the radio will turn off automatically and is unable to turn on. See section 26 for information about how to charge the batteries.

4

INSTALLING BATTERIES (REMOTE CONTROL)

The operating voltage of the remote control is 3V and requires two pieces AAA (R03) size batteries.

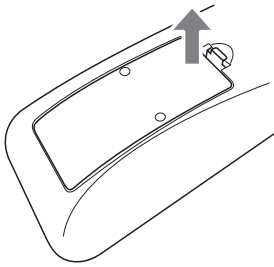

1. Open the battery door.

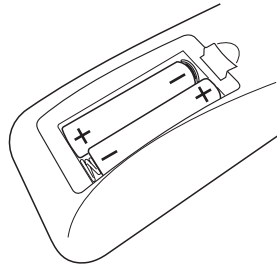

2. Insert two AAA-size batteries following the indicated polarity.

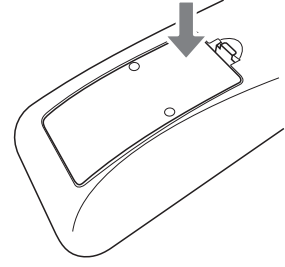

3. Close the battery door.

5

HOW TO TURN ON/OFF THE RADIO

After installing the batteries, press the [POWER] button ① on the radio or remote control ②⑨ to turn ON/OFF the radio.

Note:

1. When using the remote control, the IR transmitter ③⑩ should point towards the IR sensor ⑪ on the radio.
2. To reduce power consumption, when the radio is not used for one hour, the IR sensor LED indicator light automatically turns off, meaning that the remote control function is deactivated. Press any key on the radio to reactivate it.

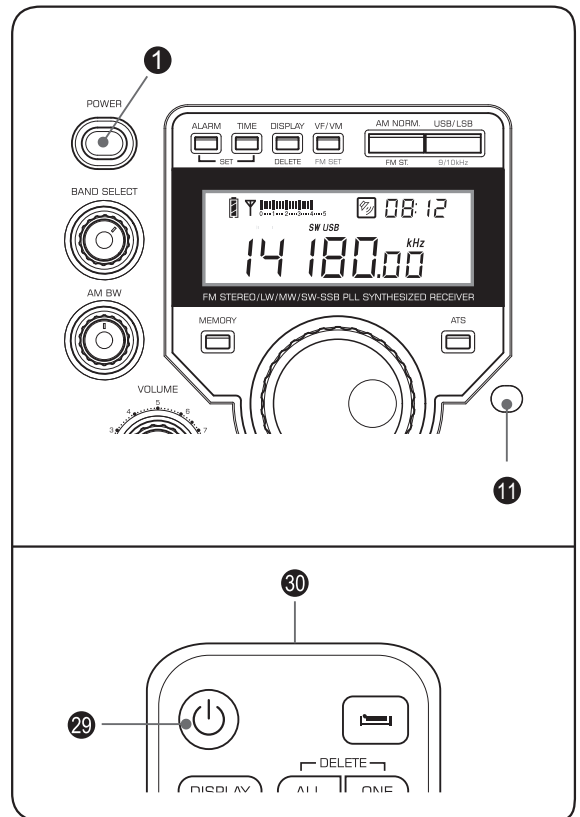

Volume control

Radio:

Rotate the [VOLUME] knob ⑩ to adjust to your desired volume level.

Remote control:

Press the [VOL+ / VOL-] button ③⑥ on the remote control for your desired volume level.

Note:

The volume output level is the combined result of adjustments made on the radio and the remote control. For maximum volume level, turn the volume knob on the radio to maximum and use the [VOL+] button on the remote control to set the digital volume level to 30.

Tone (bass, treble) control

Turn on the radio, rotate the [BASS --- TONE ---- TREBLE] knobs ⑭ / ⑮ to select your desired tone level.

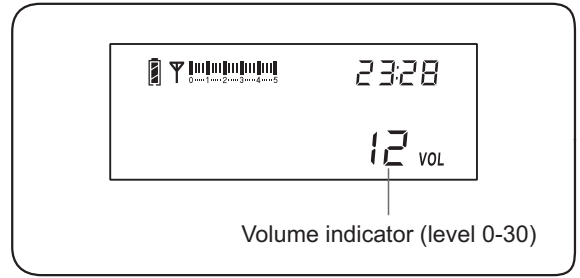

Volume display while using Remote Control

To meet the broadcasting conditions in different countries, you can preset the MW tuning step and FM frequency range following the below steps:

MW tuning step (9kHz / 10kHz) setting

In radio OFF mode, press and hold the [9/10kHz] button on either the radio ⑦ or remote control ③⑨. The LCD briefly displays “9 kHz” or “10 kHz” to indicate the selected tuning step.

9 kHz tuning step: MW frequency coverage is 522 kHz ~ 1620 kHz.

10 kHz tuning step: MW frequency coverage is 520 kHz ~ 1710 kHz.

FM frequency coverage settings

In radio OFF mode, press and hold the [FM SET] button on either the radio ⑤ or remote control ③⑧, then press repeatedly to select your desired starting point of the FM frequency range (64, 76, 87 or 88 MHz) and wait until the LCD displays “108 MHz” to automatically confirm the setting.

- LCD displays “ 64 - - ”, the frequency coverage is 64 ~ 108 MHz.
- LCD displays “ 76 - - ”, the frequency coverage is 76 ~ 108 MHz.
- LCD displays “ 87 - - ”, the frequency coverage is 87 ~ 108 MHz.
- LCD displays “ 88 - - ”, the frequency coverage is 88 ~ 108 MHz.

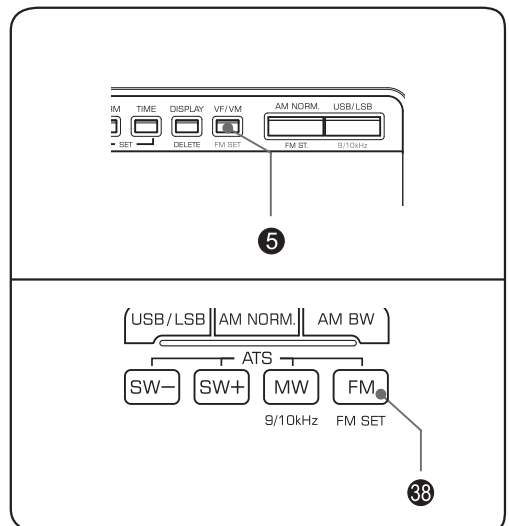
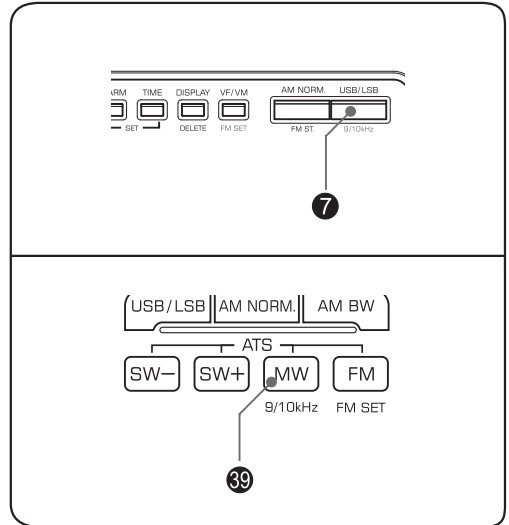

Safety Alert

1. When you build an outdoor antenna, you must pay attention to personal safety!
2. An outdoor antenna must be kept away from power lines! It must be windproof, waterproof, and requires protection from lightning strikes.
3. During a thunderstorm, do not use an outdoor antenna! Disconnect the outdoor antenna from the radio.
4. Do not use a gas pipeline or AC power outlet for grounding purposes.

1. Long Wave and Medium Wave antenna:

The S-8800 radio uses a built-in magnetic rod (ferrite) antenna to receive long wave and medium wave signals. Since this ferrite antenna is directional, minimizing interference and achieving the best reception for long wave and medium wave signals requires repositioning of the radio. If necessary, you can connect an external antenna to the “AM ANT.” external antenna socket and a ground wire to the ground (GND.) socket 22 to improve reception. Push the switch 25 to “EXT ANT.” position.

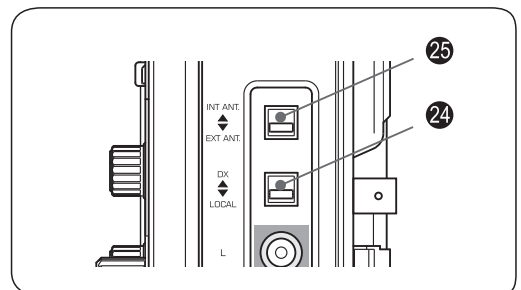
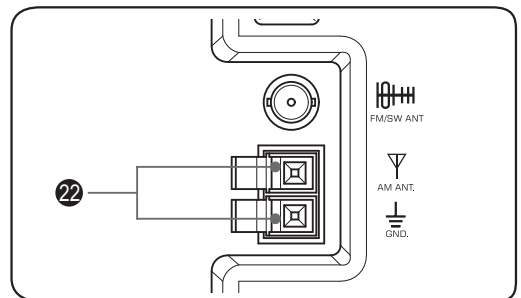
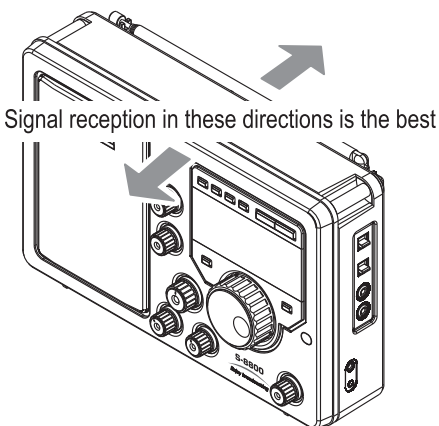

2. Antenna for Short Wave

For receiving short wave signals, you can either use the telescopic antenna 26 or an external antenna. When using the telescopic antenna, push the [INT ANT./EXT ANT.] switch 25 to “INT ANT.” position. When using an antenna connected to the external antenna socket, push the switch to “EXT ANT.” position.

Upon receiving a strong radio signal, push the [DX / LOCAL] switch 24 to “LOCAL” position; when receiving a weak signal, push the switch to the “DX” position.

“Extended” whip antenna to improve reception:

Connect the Tecsun “AN-05 external antenna” (can be purchased separately) to the telescopic antenna of the S-8800. Fix the opposite end at a high location outside the building, then push the [INT ANT. / EXT ANT.] antenna switch to “INT ANT.” position.

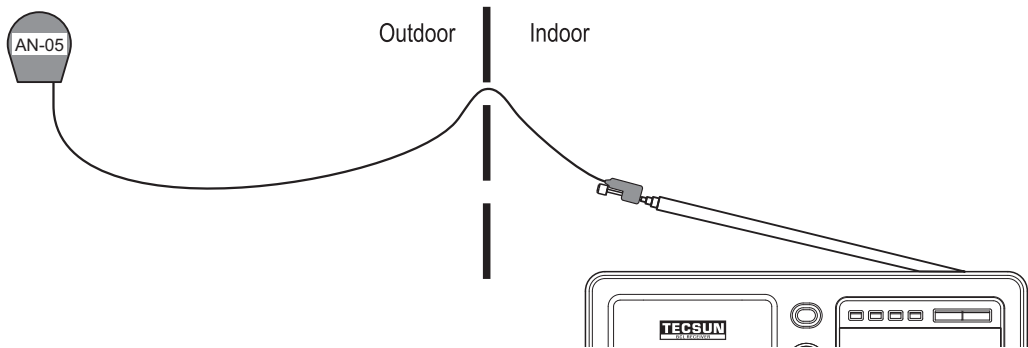

Using an external antenna:

In order to improve short wave reception, an external antenna can be connected to either the high impedance 22 or low impedance 23 external antenna socket on the back of the S-8800. When using the external antenna, push the [INT ANT. / EXT ANT.] switch to “EXT ANT.” position.

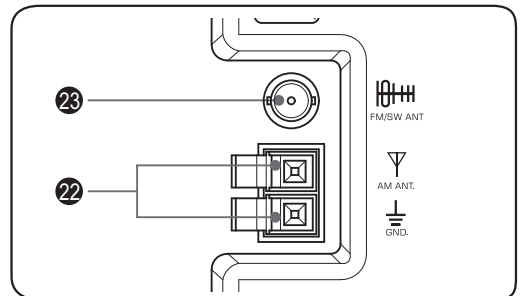

Connecting a low-impedance short wave antenna
Example: symmetrical horizontal antenna:

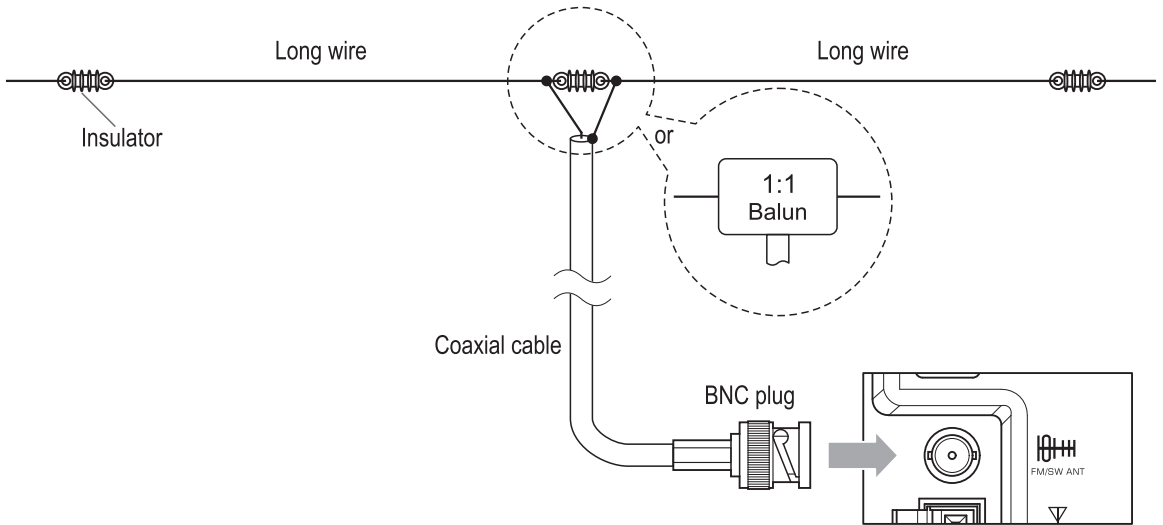

Connecting a high-impedance short wave antenna
Example: inverted L-shaped antenna

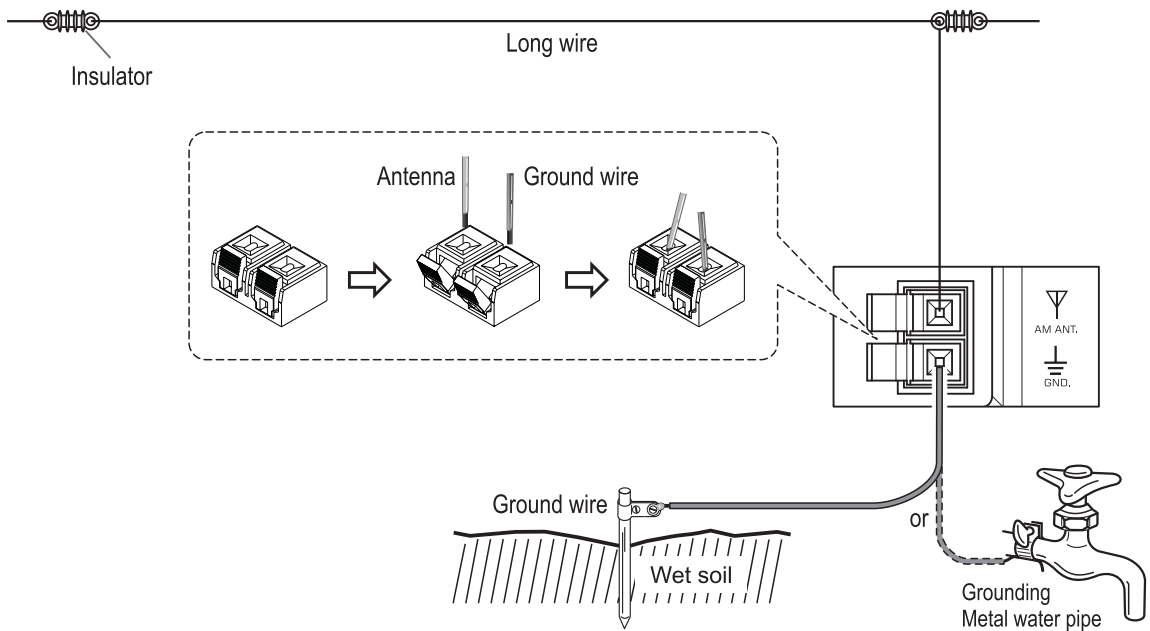

Warning: Do not use the water pipe as the ground wire for anti-lightning protection!

3. Antenna for FM

For receiving FM signals, you can either use the telescopic antenna 26 or an external antenna.

When using the telescopic antenna, push the [INT ANT. / EXT ANT.] switch 25 to "INT ANT." position. Changing the length and angle of the telescopic antenna can improve the reception.

When using an antenna connected to the external antenna socket 23, push the switch to "EXT ANT." position.

Both FM external antennas and VHF (channels 1 to 12) TV antennas can be used to enhance FM signals.

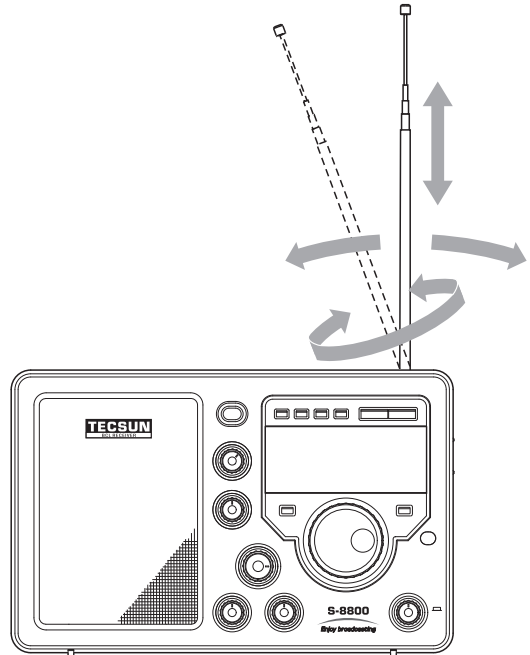

Note:

Because external VHF TV antennas are directional, a rotatable antenna with remote control is suggested.

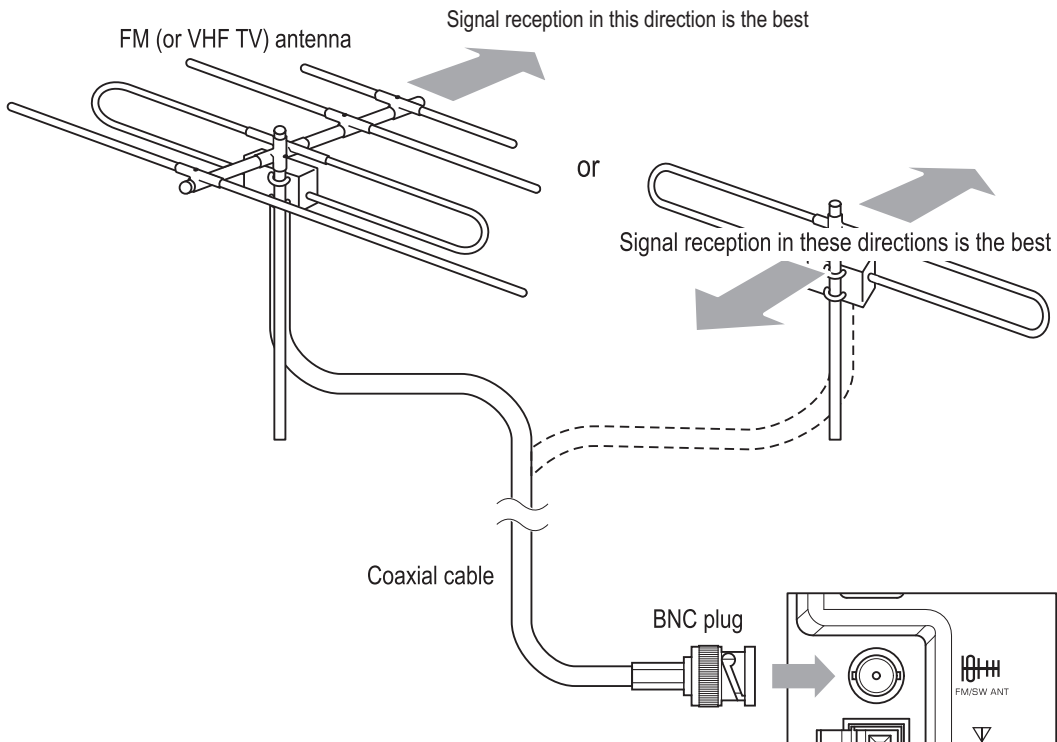

Broadcasting knowledge:

How to achieve long-distance FM radio reception (FM-DX)?

To enhance reception, use an outdoor VHF antenna or suitable FM antenna (low attenuation coaxial cable), fix it as high as possible (take into account the antenna usage safety alerts) and point it in the direction of the desired FM broadcast. If the signal is weak, you may require installing a low-noise antenna amplifier. For FM-DX purposes, more antenna sections can increase the signal. Adding more antennas to create an antenna array can further enhance signal gain and directionality.

9

FREQUENCY BAND SELECTION

To select your desired frequency band, rotate the [BAND SELECT] knob ①9 on the radio or press the corresponding band button ([FM] / [MW] / [SW-] / [SW+]) on the remote control (③8, ③9, ④1); for LW band selection, press the [MW] button twice.

To change meter bands when tuning the SW band, press and then turn the [FINE TUNING] knob ⑬ on the radio, or press the [SW-]/[SW+] buttons on the remote control.

Note:

To turn ON/OFF LW band, in radio OFF mode, press and hold the [LW ON/OFF] button ⑨ until “LW ON” or “LW OFF” appears on the display. Alternatively, press and hold the [2] key on the remote control.

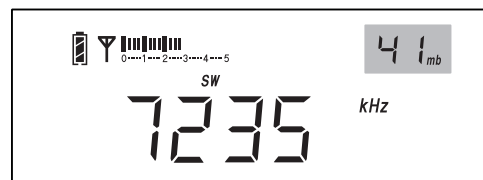
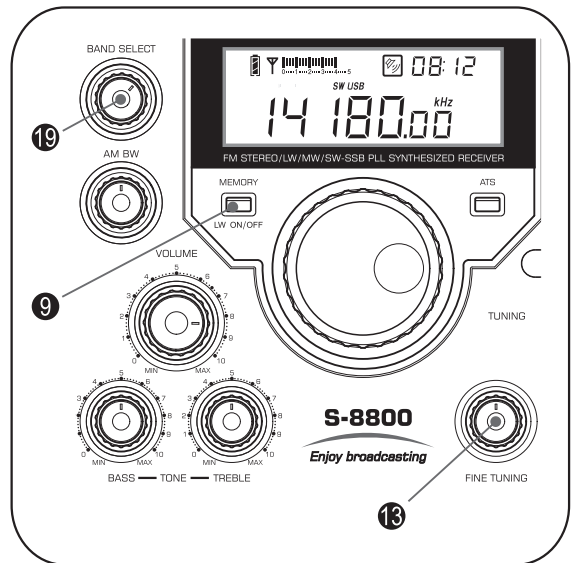

SW meter band indicator (41mb)

VF (View Frequency):

Press the [VF/VM] button on the radio **5** or remote control **45**. When the clock or alarm time is shown in the upper right corner of the display, the VF mode is activated. If it shows the preset station number, press the [VF/VM] button again.



View Frequency display

VM (View Memory):

Press the [VF/VM] button. When the preset station number "P0XX" is shown in the upper right corner of the display, the VM mode is activated. If it shows the clock or alarm time, press the [VF/VM] button again.



View Memory display

Note:

When the memory contains no stored stations, it is not possible to switch between VF and VM mode; the device will automatically be in VF mode.

Before tuning into FM or short wave stations, push the [INT ANT.] switch **25** to the proper position following the instructions about antenna usage as described in section 8.

MANUAL TUNING

In VF (View Frequency) mode, rotate the [TUNING] knob **12** to search for your desired station. Alternatively, use the tuning options [◀◀], [▶▶], [▲], and [▼] **46** on the remote control.

AUTO SCAN TUNING

In VF mode, press and hold the [VF/VM] button **5** on the radio or [SCAN] button **44** on the remote control. The scanning indicator " >> " advances from left to right while the device automatically scans the available stations, staying on each station for about 5 seconds. To stop the auto scan function, rotate the [TUNING] knob **12** or press the [SCAN] button **44** on the remote control.

Note:

The frequency scanning direction is based on the last used tuning direction. When the last used tuning direction was up frequency/down frequency, then the scanning direction is also up frequency/down frequency.

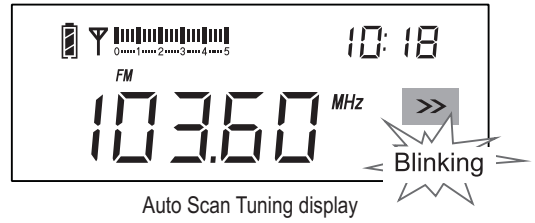

DIRECT KEYPAD ENTRY

In VF mode, you can press the numeric keys [0-9] 33 on the remote control to directly enter a station frequency.

For example, tuning into radio programs on FM 105.2 MHz:

1. Press the [VF/VM] button 45 on the remote control to enter VF mode.
2. Press the [FM] button 33 to enter the FM frequency band.
3. To select the FM 105.2 MHz frequency, press the [1], [0], [5], [2] keys subsequently.

12 AM BW (bandwidth) SELECTION

When listening to AM frequency bands (LW, MW, SW and SSB), rotate the [AM BW] knob 18, or press the button 37 on the remote control, to adjust the bandwidth and enhance the signal.

In LW / MW / SW mode:

Adjust to your desired bandwidth:
2.3 kHz / 3.0 kHz / 4.0 kHz / 6.0 kHz

In SSB mode:

Adjust to your desired bandwidth:
0.5 kHz / 1.2 kHz / 2.3 kHz / 3.0 kHz / 4.0 kHz

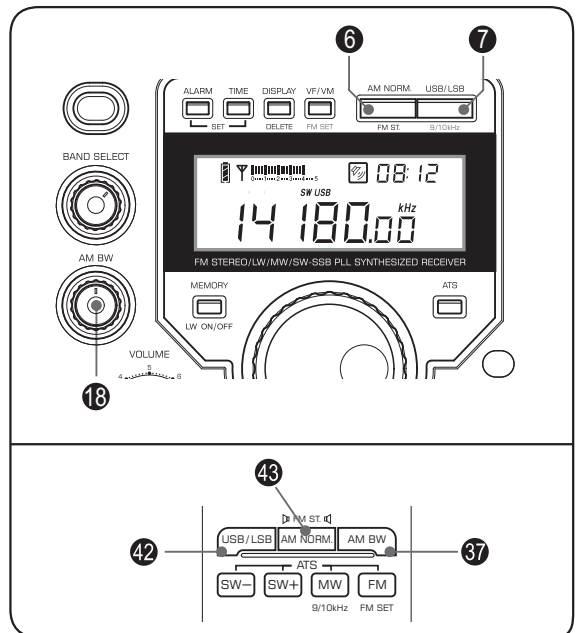

Choosing a wider band

(local stations / strong signals):

It has better audio fidelity when receiving strong signals or local stations.

Choosing a narrower band (long distance stations / weak stations):

1. Suitable for receiving weak and long distance stations. A narrower band is able to limit interference from adjacent strong signals and reduce background noise.
2. When using a narrower band for SSB signals, the sound will be slightly distorted, which is a normal phenomenon.

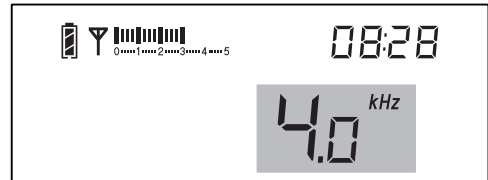

AM Bandwidth display

13 SSB (Single Side Band) SELECTION

When listening to AM frequency bands (LW, MW, SW), press the [USB/LSB] button ⑦ or ④② repeatedly to select your desired side band mode.

USB: Upper Side Band

LSB: Lower Side Band

To exit the SSB mode and resume normal listening, press the [AM NORM.] button ⑥ or ④③.

Broadcasting knowledge:

What is SSB (Single Side Band)?

LW, MW and SW broadcasts belong to the AM (Amplitude Modulation) broadcasting mode, which has a spectrum composed of three parts: (1) carrier wave, (2) lower sideband (LSB), and (3) upper sideband (USB):

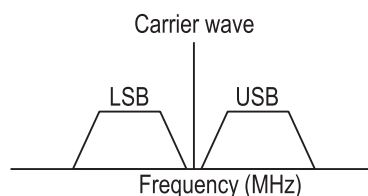

The figure shows an AM signal that has two sidebands with information, each a copy of the other, and the carrier wave. To enhance the efficiency of the signal, the carrier wave and either one of the sidebands can be eliminated. What remains is a single side band (SSB).



Besides the capability of receiving AM signals, a radio device requires a specific demodulator to receive the information from SSB signals. The advantage of SSB transmissions is the narrow bandwidth (gives better selectivity and less noise), higher power efficiency and longer transmission distance. The disadvantage is that the sound is slightly distorted, which makes it primarily suitable for less demanding audio quality communication.

14 FM STEREO

1. When listening to FM broadcasts through stereo earphones, press the [FM ST.] button **6** or **43** to activate the stereo function. If the FM broadcast is transmitted in stereo, the FM stereo indicator “**FM ST**” is displayed on the LCD. When the FM signal is weak, it is advised to turn off the stereo function.

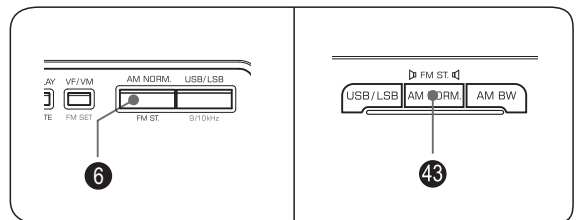

- Since stereo sound does not function via the speaker of the device, it is advised to turn off the stereo function to improve sound quality while listening via the speaker.
- If the FM station is not broadcasted in stereo, or the stereo signal is too weak, the “**FM ST**” symbol does not appear and the stereo function will not be activated.

Broadcasting knowledge:

- What kind of signal can interfere with FM broadcasts?
The reception of a particular FM station can experience interference from powerful VHF TV signals as well as strong signals from adjacent FM stations. Several strong FM stations can also interfere with each other.

2. How to reduce interference when listening to FM radio?

- Change the length of the telescopic antenna: In general, when listening to lower frequencies (such as 89.3 MHz), fully extend the telescopic antenna. When listening to higher frequencies (such as 105.2 MHz), reduce the length of the antenna;
- Change the angle and direction of the telescopic antenna;
- Move to a different location, then try listening to the station again;
- Turn off the stereo function;
- Connect an external directional antenna (do not use it during a thunderstorm).

15 STORING STATIONS INTO MEMORY

This device can store 650 stations into its memory. Please refer to the chart below:

BAND \ MEMORY	Memory for each band	
	P	ATS
FM	100	✓
LW	100	✓
MW	100	✓
SW	250	✓
SSB	100	✓

METHOD 1: Manual storage

Radio operation: [MEMORY] button 9

Remote control operation: [M] button 48

- Turn on the radio, select VF mode and tune into your desired radio station.
- Press the [MEMORY] / [M] button. The memory location "P00X" blinking in the upper right corner is the first available empty storage location.
- Press the [MEMORY] / [M] button to confirm, or rotate the [TUNING] knob 12 to select your desired alternative memory location. If the alternative memory location already contains a stored station, then this will be replaced by the new station.

When using the remote control, in VF mode, you can directly key in the station frequency. Press the [M] button, then key in a memory location. Press the [M] button again to confirm.

METHOD 2: Semi-auto storage

Radio operation: [VF/VM] ⑤ and [MEMORY] buttons ⑨

Remote control operation: [SCAN] ④④ and [M] buttons ④⑧

- i) Turn on the radio, select VF mode and rotate the [BAND SELECT] knob ⑱ to choose your desired FM/LW/MW/SW band.
- ii) Press and hold the [VF/VM] button.
The scanning indicator [>>] advances from left to right while the device automatically scans the available stations, staying on each station for about 5 seconds.
- iii) While operating the “Auto Scan” function, press the [MEMORY] / [M] button on either the radio or remote control to store stations into memory, thereby avoiding storing any unwanted stations. To stop the auto scan function, rotate the [TUNING] knob ⑫ or press the [SCAN] button on the remote control.

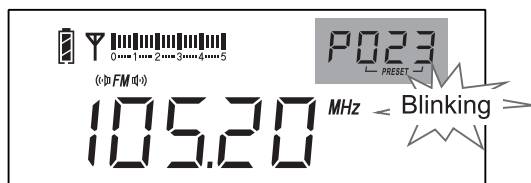

METHOD 3: Auto Tuning Storage (ATS)

Radio operation: [ATS] ⑩ button

Remote control operation: [FM] ③③, [MW] ③⑨ and [SW-] [SW+] buttons ④①

While activating the ATS function through the below instructions, the frequency advances and “PRESET” blinks in the upper right corner of the LCD. The memory location indicator on the LCD changes when available stations are stored. When the frequency stops running, it means the ATS operation has been completed; all available stations are now stored into memory. Rotate the [TUNING] knob or press the [◀◀] [▶▶] buttons ④⑥ on the remote control to view all the stored stations.

FM ATS

- i) Turn on the radio, select VF mode and rotate the [BAND SELECT] knob ⑱ or press the [FM] button on the remote control to choose FM band.
- ii) Press the [ATS] button on the radio or press and hold the [FM] button on the remote control to activate the auto tuning storage function.

MW ATS

- i) Turn on the radio, select VF mode and rotate the [BAND SELECT] knob ①⑨ or press the [MW] button ③⑨ on the remote control to choose MW band.
- ii) Press the [ATS] button ⑩ on the radio or press and hold the [MW] button on the remote control to activate the auto tuning storage function.

LW ATS

- i) Turn on the radio, select VF mode and rotate the [BAND SELECT] knob ①⑨ or press the [MW] button ③⑨ on the remote control twice to choose LW band.
- ii) Press the [ATS] button ⑩ on the radio or press and hold the [MW] button on the remote control to activate the auto tuning storage function.

SW ATS

Mode A:

Follow the below steps to perform the ATS function within all meter bands.

- i) Turn on the radio, select VF mode and rotate the [BAND SELECT] knob ①⑨ or press the [SW-] or [SW+] ④① button on the remote control to choose SW band.
- ii) Press the [ATS] button ⑩ on the radio, or press and hold the [SW-] button on the remote control to activate the auto tuning storage function.

Mode B:

Follow the below steps to perform the ATS function within your selected SW meter band.

- i) Turn on the radio, select VF mode and rotate the [BAND SELECT] knob ①⑨ or press the [SW-] or [SW+] button on the remote control to choose SW band.
- ii) After selecting your desired SW meter band, press and hold the [SW+] button on the remote control to activate the auto tuning storage function.

Note:

1. When using the ATS function for FM, LW, MW or SW mode A, previously stored radio stations are automatically replaced by the newly found stations.
2. When using the ATS function in SW mode B, previously stored stations will not be replaced; all newly found radio stations will be stored in blank memory locations.
3. If there is too much interference in your surroundings, or many mirror stations or blank stations are stored during the ATS operation, extend the telescopic antenna to enhance FM and SW reception, or rotate the radio for better reception of LW and MW, because the built-in MW ferrite bar is directional. You may also try to push the [DX / LOCAL] switch ②④ to [LOCAL] position to enhance ATS performance.

4. For MW, due to the characteristics of radio waves, more radio stations can be received during nighttime than daytime.
5. It is advised to repeat the ATS function for SW from time to time, since SW reception is affected by a variety of factors. SW radio waves are affected by the condition of the ionosphere, which varies according to the time of day, seasons and the state of the sun. SW transmissions are also not continuous, which means that these cannot be received the whole day. Furthermore, the receiving environment or the receiving equipment such as the (external) antenna used, will also affect the ATS result.

Broadcasting knowledge:

Why are more MW stations received at night than during the day?

MW stations emit radio signals or “waves” in two ways: (1) along the surface of the earth, so-called “ground waves”, and (2) by letting the signal travel from the radio transmitter and then bounce off the ionosphere in the atmosphere back to the surface, the so-called “sky waves”. Ground wave propagation is generally not more than two to three hundred kilometres, due to a strong absorption effect by the surface of the earth.

During daytime, the ionosphere density increases under the effect of sunlight, making sky wave ionospheric propagation difficult. Signals are partially absorbed by the ionosphere with only limited reflection back to earth. Because ground waves are also easily absorbed by the earth, this results in MW signals not being able to spread over long distances. Therefore, during daytime, it is quite difficult to receive long-distance MW broadcasts.

During nighttime, the ionosphere becomes thinner because the atmosphere is no longer exposed to sunlight. A significant reduction in electrons and ions in the ionosphere reduces its absorption effect of MW radio waves. MW sky waves are more easily reflected back to earth and can spread over longer distances, which is why more MW stations can be received at night.

Turn on the radio, select your desired FM/LW/MW/SW band and press the [VF/VM] button ⑤ or ④⑤ to enter the View Memory [VM] mode. When in VM mode, the memory location “PXXX” is displayed in the upper right corner of the LCD. Browse all stored stations through any of the below methods.

METHOD 1: Manually browsing stored stations

In VM mode, rotate the [TUNING] knob ⑫ on the radio or press the [◀◀] or [▶▶] button ④⑥ on the remote control to select your desired stored station.



Browse stored stations

METHOD 2: Auto browsing stored stations

In VM mode, press and hold the [VF/VM] button ⑤ on the radio or [SCAN] button ④④ on the remote control. The Auto Browsing function is activated, indicated by the “Preset” symbol blinking in the upper right corner of the LCD. The device will play each stored station for about 5 seconds. To stop browsing, rotate the [TUNING] knob ⑫ on the radio or press any key on the remote control.

Note: The auto browsing direction is based on the last used manual browsing direction. When the last used manual browsing direction was up frequency / down frequency, then the auto browsing direction is also up frequency / down frequency.

METHOD 3: Direct key in station memory location

In VM mode, use the numeric keys ③③ on the remote control to directly key in the station memory location. For example, press [0], [2], [3] when the station memory location is “P023”.

Note:

If the entered station memory location is not in use, the LCD displays “- - - -”.

Choose the frequency band from which to delete stored stations, and then enter the View Memory (VM) mode. Rotate the [TUNING] knob ⑫ to select a station, then use any of the below methods to delete:

METHOD 1: Delete a single station

Press and hold the [DELETE] button ④ on the radio, or press and hold the [ONE] button ③② on the remote control, until “DEL” and the station location “PXXX” blink on the LCD. Press the [DELETE] / [ONE] button again to confirm.

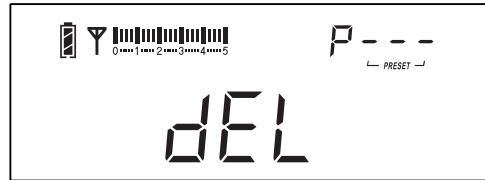

Deleting a single stored station

Note:

If the [DELETE] / [ONE] button is not pressed within 3 seconds for confirmation, the delete function is automatically exited.

METHOD 2: Semi-auto station delete

Press and hold the [VF/VM] button ⑤ on the radio or [SCAN] button ④④ on the remote control. The Auto Browsing function is activated, indicated by the “PRESET” symbol blinking in the upper right corner of the LCD. The device will play each stored station for about 5 seconds. Press the [DELETE] button ④ on the radio, or the [ONE] button ③② on the remote control, to delete the selected station. No confirmation is required and the browsing continues immediately. To stop the auto browse function, rotate the [TUNING] knob ⑫ or press any key on the remote control.

METHOD 3: Delete all stored stations within a frequency band

In VM mode, select a frequency band and then press and hold the [DELETE] button ④ on the radio, or the [ALL] button ③② on the remote control, until “DEL” and “ALL” are blinking on the LCD. Press the [DELETE] / [ALL] button again to confirm.

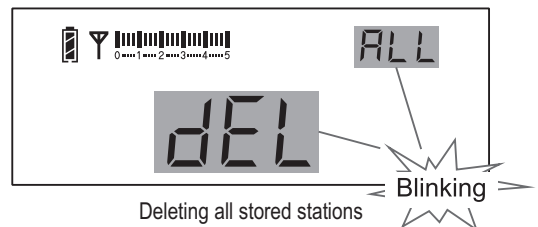

Deleting all stored stations

METHOD 4: Delete all stored stations

In power OFF mode, press and hold the [DELETE] button ④ on the radio, or the [ALL] button ③② on the remote control, until “DEL” and “ALL” are blinking on the LCD. To confirm, press the [POWER] button on the radio or remote control.

Broadcasting knowledge:

Why is the SW broadcast sound so unstable, continuously changing between large and small sound?

The cause can be found in the unstable nature of the ionosphere, which reflects SW signals back to earth. The height, thickness and density of the ionosphere influence how well SW signals are reflected, but these conditions change constantly, especially during daytime. The strength of the signal that is received by the antenna is therefore also constantly changing. When listening to SW radio broadcasts, this results in sudden changes between large and small sound.

18 AUTO SORTING MEMORY

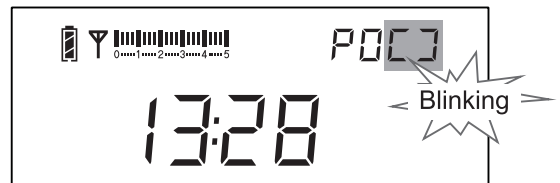

This function is able to remove duplicate stations, which is especially useful after storing stations manually, as you might store a station more than once. It also sorts the sequence of all stored stations according to frequency.



Display of Auto Sorting Station memory

Turn off the radio, press and hold the [] ("0" key) button on the remote control until " P00 " blinks in the upper right corner of the LCD; the device is reorganizing all stored stations. When completed, the display goes back to showing the alarm time in the upper right corner.

19 CLOCK SETTING (24-hour clock)

1. Press and hold the [TIME] button  until the hours indicator starts blinking. Rotate the [TUNING] knob  to adjust the hours.
2. Press the [TIME] button to confirm the hours setting.
3. The minutes indicator starts blinking. Rotate the [TUNING] knob to adjust the minutes.
4. Press the [TIME] button to confirm the minutes setting.

1. Press and hold the [ALARM] button ② on the radio until the hours indicator starts blinking in the upper right corner of the LCD. Rotate the [TUNING] knob ⑫ to adjust the hours. Then press the [ALARM] button to confirm the hours setting.
2. The minutes indicator starts blinking. Rotate the [TUNING] knob to adjust the minutes. Press the [ALARM] button to confirm the minutes setting.
3. Now rotate the [TUNING] knob to set your desired "Alarm Off Timer" (1-90 minutes). This is the duration after which the radio will turn off automatically. Press the [ALARM] button to confirm the setting.
4. The alarm ON indicator "☞" on the LCD signifies that the alarm has been set. To deactivate the alarm, press the [ALARM] button and "☞" disappears from the display.

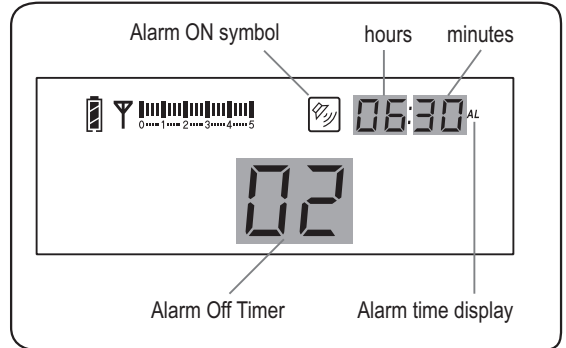

How to preset the alarm station?

1. In radio ON mode, tune to your desired radio station and set an appropriate alarm volume level.
2. Press the [MEMORY] button ⑨. While the stored station location "PXXX" blinks in the upper right corner of the LCD, quickly press the [ALARM] button ② to confirm the alarm station. The alarm ON indicator "☞" on the LCD signifies that the alarm has been set. To deactivate the alarm, press the [ALARM] button and "☞" disappears from the display.

Note:

When the alarm goes off, the upper right corner of the LCD shows the countdown of minutes before the device turns off automatically (Alarm Off Timer).

How to stop the Alarm Off Timer?

To stop the Alarm Off Timer and enter normal radio listening mode, press the [POWER] button on either the radio ① or remote control ⑳. Press the [POWER] button again to turn off the radio.

21

SLEEP TIMER SETTING

It is possible to set a timer (1-120 minutes) after which the device automatically turns off. In power OFF mode, press and hold the [POWER] button ❶ on the radio, then use the [TUNING] knob ❷ to adjust the setting. Press the [DISPLAY] button ❹ to confirm the setting.

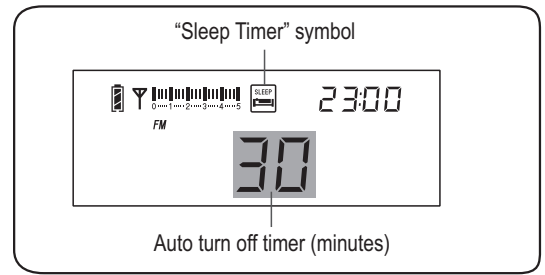

Alternatively, in power ON mode, press the [] button ❸ on the remote control repeatedly to select your desired Sleep Timer. Press the [ENTER] button ❹ to confirm the setting.

Note:

When you turn off the radio, the Sleep Timer setting is automatically cancelled.

22

STEREO LISTENING USING EARPHONES

For stereo sound listening, connect earphones (not included) to the radio by inserting the Φ 3.5mm stereo plug into the [EARPHONES] jack ❷.

Caution: When using earphones, the volume level should be adjusted to an appropriate level. Avoid prolonged earphone use, this can cause hearing loss.

23

AUDIO LINE OUT FUNCTION

Connect an audio cable (not included) to the [L & R LINE OUT] jack ❷ of the radio and a stereo amplifier. Rotate the [VOLUME] knob ❸ or press on the [VOL +] and [VOL-] button ❹ on the remote control to adjust the audio line out level.

DISPLAY

While listening to the radio:

- i) Press the [DISPLAY] button 4 on the radio to display the clock time “00:00”, alarm time “00:00 AL” or memory location “PXXX” (only in VM mode) in the top right corner of the LCD.
- ii) Press the [TIME] button 3 on the radio to display either the station frequency or clock time.
- iii) Press the [DISPLAY] button 49 on the remote control to show either the station frequency or clock time.

Note:

When the LCD display is set to clock time, press the [POWER] button twice to turn off the radio.

Backlight

This device has an intelligent backlight function, meaning that the backlight is lit for about 5 seconds after operating any key or knob. To turn on the backlight continuously, turn off the radio, then press and hold the [3] key on the remote control until “ON” appears on the LCD. Press and hold again to switch back to intelligent lighting function.

This feature is used to quickly switch between two stations (not limited to a single frequency band).

Tune to your desired station-A, then press and hold the [BACK] button 47 on the remote control to store it as the “return station”. When tuning other frequencies, press the [BACK] button at any time to return to the stored station-A.

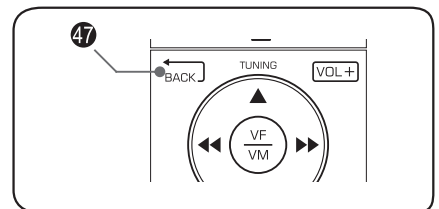

To utilize the built-in charging function, insert 2 pieces 18650 lithium battery, then connect a 5V / 1A DC adaptor with a USB mini-B plug to the device. The battery level indicator on the LCD advances from down to up while charging, with the symbol “Charge” blinking below the charging timer. Charging automatically stops when the batteries are fully charged (“  ”).

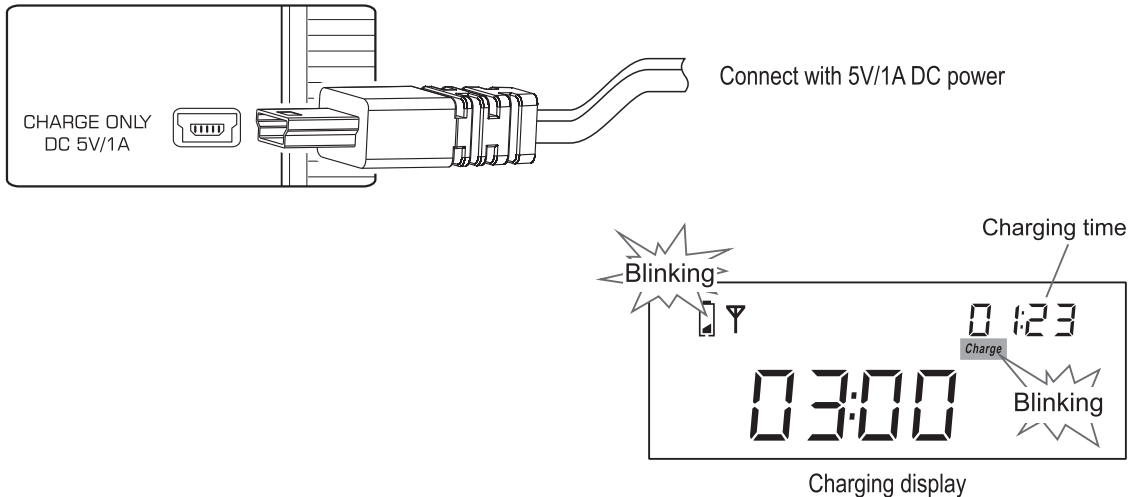

Lithium battery safety information (important!)

Improper use of lithium batteries may result in an explosion, please read the below information carefully:

1. Do not expose the batteries to heat or high pressure, do not drop the batteries, prevent children from playing with electric currents.
2. Replace with the same type of lithium battery for the usage of this device.
3. Do not short-circuit the batteries, do not open or amend, do not expose it to damp environments.
4. If not using for an extended period of time, remove the batteries and store in a safe manner. Please use a non-conductive material to wrap the batteries in order to avoid direct contact with metal. You can avoid damage by keeping the batteries in a cool dry place.
5. Dispose of the batteries properly; do not put into fire or water.
6. Do not expose to direct sunlight for a prolonged period, avoid heat, deformation or smoldering. This will reduce the performance and life span of the batteries.
7. Please consciously abide by aviation regulations; lithium batteries are strictly prohibited from placing into check-in luggage.

QUESTIONS	ANSWERS	SOLUTIONS
Cannot turn on the radio	<ul style="list-style-type: none"> - Batteries have no power. - Batteries are installed incorrectly. - Firmware glitch. 	<ul style="list-style-type: none"> - Replace or charge the batteries. - Take note of the correct polarity direction, then reinstall the batteries. - See section 28 on Firmware Reset.
When turned on, even when the volume knob is set to maximum, the volume is still very low.	<ul style="list-style-type: none"> - The volume level on the remote control has been set to a very low level. 	<ul style="list-style-type: none"> - Turn on the radio, then press the [VOL+] button on the remote control until it reaches level 30.
Radio turns off automatically while listening.	<ul style="list-style-type: none"> - Battery has no power. - Sleep timer is activated. 	<ul style="list-style-type: none"> - Replace or charge the batteries. - Turn the radio on again.
During ATS, some stations cannot be stored. Some stored stations have noise.	<ul style="list-style-type: none"> - Signal of stations is too weak. - There is a source of interference in your area. 	<ul style="list-style-type: none"> - Search stations manually. - Adjust the antenna length or move to a different location and try again.
Only a few FM stations can be received in Japan / Russia.	<ul style="list-style-type: none"> - FM frequency may have been set to 87 - 108 MHz. 	<ul style="list-style-type: none"> - Turn off the radio, press & hold the [FM SET] button to select the accurate FM frequency range (76 - 108 MHz / 64 - 108 MHz).
Poor MW reception in USA.	<ul style="list-style-type: none"> - USA uses 10 kHz MW tuning steps, the device may still be set to 9 kHz. 	<ul style="list-style-type: none"> - Turn off the radio, press the [9/10kHz] button to select the accurate tuning step.
The sound level of SW SSB broadcasts is too low.	<ul style="list-style-type: none"> - The device is set to a narrow bandwidth. 	<ul style="list-style-type: none"> - Rotate the [AM BW] knob to select a wider bandwidth.
When the alarm goes off, there is only noise.	<ul style="list-style-type: none"> - Did not set a proper preset radio station for the alarm. - Or there is no broadcast at that frequency at that specific time. 	<ul style="list-style-type: none"> - Preset your alarm station properly. - Make sure it is possible to receive radio broadcasts at that time at your location.
The charging time becomes shorter and shorter.	<ul style="list-style-type: none"> - The rechargeable batteries are getting old. 	<ul style="list-style-type: none"> - Replace the old rechargeable batteries with new ones.

This device works on advanced and stable firmware to enhance users' enjoyment. In the event that a sudden firmware glitch does occur, press the [RESET] button to return to normal operation; stored stations will not be lost when resetting the firmware.

The [RESET] button is located behind the [TUNING] knob ⑫ :

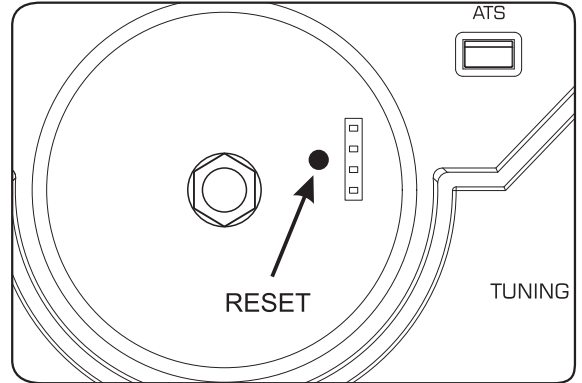

- 1) Gently pull the [TUNING] knob from the device.
- 2) Use a pointy object to press the [RESET] button.
- 3) Put the [TUNING] knob back into position.

Issues that might occur due to a sudden firmware glitch:

- Device cannot be powered on.
- Display does not turn on or behaves erratically.
- Buttons do not respond when pressed.

FREQUENCY RANGE AND TUNING STEPS

LW: 100 ~ 519 kHz, at 1 kHz / 9 kHz tuning step

MW: 520 ~ 1710 kHz, at 1 kHz / 10 kHz tuning step (North & South America)
522 ~ 1620 kHz, at 1 kHz / 9 kHz tuning step
(Asia, Africa, EU & Oceania regions)

SW: 1711 ~ 29999 kHz, at 1 kHz / 5 kHz tuning step
(While using SSB mode reception for the above bands,
the tuning step is at 10Hz / 1 kHz)

FM: 64 ~ 108 MHz (Russia, the Caucasus, the Caspian Sea and parts of the Black Sea region)

76 ~ 108 MHz (Japan)

87 ~ 108 MHz (China and Europe)

88 ~ 108 MHz (USA)

(FM frequency tuning step is 10 kHz / 100 kHz)

S/N SENSITIVITY

LW: (S / N = 26dB) better than 3mV / m

MW: (S / N = 26dB) better than 1mV / m

SW: (S / N = 26dB) better than 20 μ V

SSB: (S / N = 10dB) better than 1 μ V

FM: (S / N = 30dB) better than 3 μ V

SELECTIVITY

LW / MW: > 50dB (BW = 6 kHz)

SW: > 50dB (BW = 6 kHz)

FM: > 60dB (150 kHz)

S/N RATIO

LW / MW: better than 40dB

SW: better than 45dB

FM: better than 65dB

IF FREQUENCY

AM: 1st IF frequency: 55.845 MHz

2nd IF frequency: 10.7 MHz

3rd IF frequency (DSP): 45 kHz

FM: 128 kHz

FM STEREO SEPARATION: better than 35dB

OUTPUT POWER (distortion 10%): \geq 900mW

STATION MEMORIES:

FM: 100 stations

LW: 100 stations

MW: 100 stations

SW: 250 stations

SSB: 100 stations

QUIESCENT CURRENT

Off mode: <130 μ A

FM: <46mA

LW / MW: <86mA

SW: <97mA

SSB: <97mA

SPEAKER

Impedance: 8Ω

Power: 2W

STEREO EARPHONES JACK: 32Ω, Φ3.5mm

POWER SUPPLY

Rechargeable battery: 2 x 18650 lithium battery (7.4V)

Battery for remote control: 2 x AAA size battery (3V)

External charger: DC 5V / 1A

UNIT DIMENSIONS: 272 x 173 x 88 mm

30

RADIO MAINTENANCE

1. Keep it dry. Rain, humidity and other types of liquids or moisture can contain minerals that may cause corrosion to components. If the device does accidentally get wet, remove the batteries and wait for the radio to dry completely before placing them back.
2. Do not store the device in hot areas above +40°C. High temperatures can shorten the life span of certain components.
3. Do not place or store the device in cold environments lower than -5°C. Otherwise, when the surrounding temperature rises to room temperature, internal moisture may develop and damage the circuit board and LCD display.
4. Do not drop, hit, or smash the device.
5. Do not use harsh chemicals, cleaning solvents, or strong detergent to wash the device. Use a clean, soft, dry cloth to clean the screen.
6. Do not attempt to disassemble the device to adjust internal parameters.

MEMORANDUM

MEMORANDUM

MEMORANDUM

TECSUN

TECSUN ELECTRONIC IND. LTD.

Address: Rm 11, 13/F, Block A, Hoi Luen Ind. Ctr.,
55 Hoi Yuen Road, Kwun Tong, Kowloon, Hong Kong.

E-mail: tecsun@on-nets.com

Website: www.tecsun.com.cn